

System Diagram

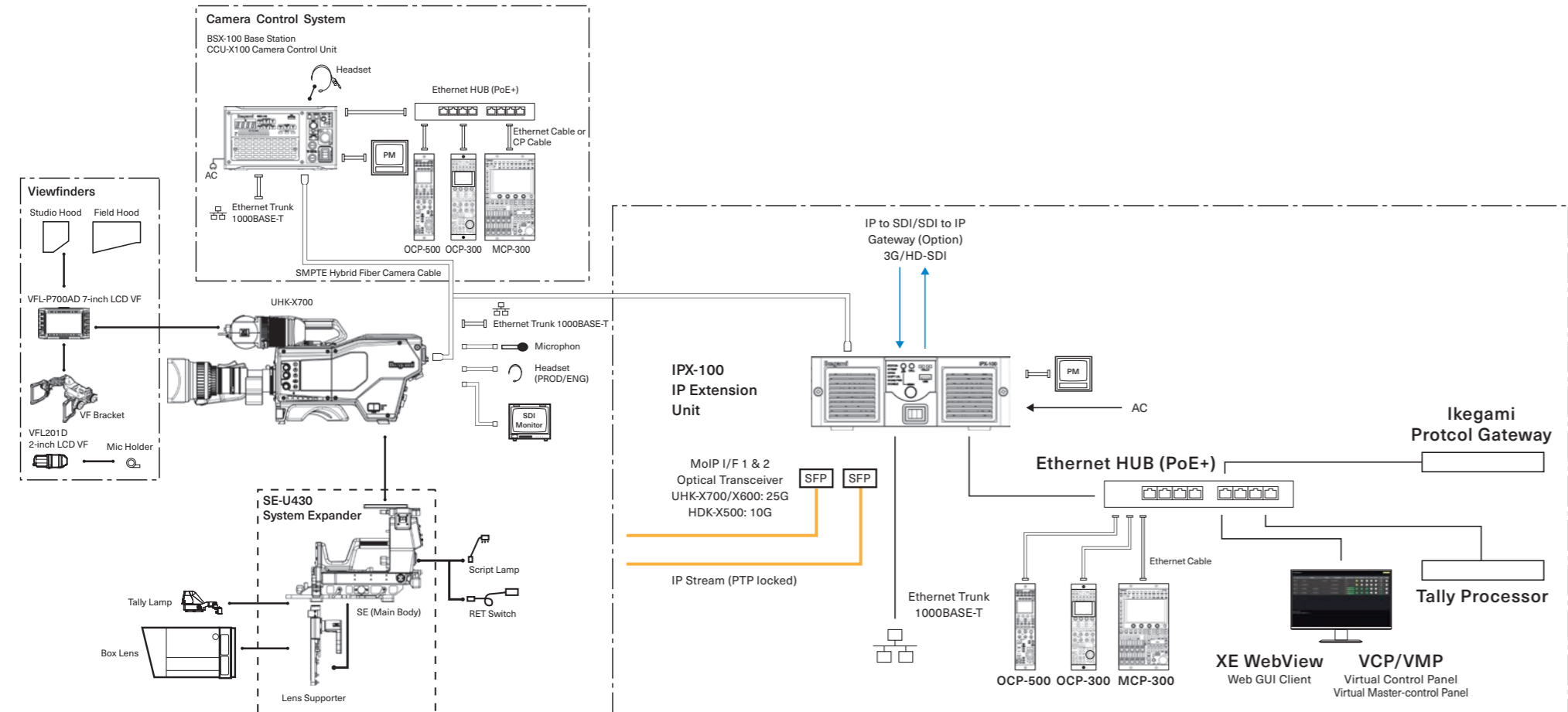

Design and specifications are subject to change without notice

Ikegami Tsushinki Co., Ltd.

■ URL : www.ikegami.co.jp/en/

■ Head Office : 5-6-16 Ikegami, Ohta-ku, Tokyo 146-8567, Japan TEL.+81-(0)3-5700-1111 / FAX.+81-(0)3-5700-1137
 ■ Beijing Office : Tower A Room No.823-824 Jia Tai International Mansion No.41 East Fourth Ring Road, Chaoyang District, Beijing, China TEL / FAX.+86-10-8571-0350

Ikegami Electronics (U.S.A.), INC.

■ URL : www.ikegami.com

■ Headquarters : 300 Route 17 South, Mahwah, NJ 07430, U.S.A. TEL.+1-201-368-9171 / FAX.+1-201-569-1626

Ikegami Electronics (Europe) GmbH

■ URL : www.ikegami.de

■ Headquarters : Ikegami Strasse 1, D-41460 Neuss, Germany TEL.+49-(0)2131-1230 / FAX.+49-(0)2131-102820

Ikegami Electronics Asia Pacific Pte. Ltd.

■ URL : sg.ikegami.co.jp

■ Headquarters : 1 Tampines Central 5, #06-04 CPF Tampines Building, Singapore 529508 TEL.+65-6260-8820 / FAX.+65-6260-8896



U552A2412-IB



Ikegami



4K/HD CAMERA SYSTEM

UNICAM XE

Reach for Reality



Xceptional Engineering
Xcellence Enabler
Xtended Evolution

UNICAM XE

HDK-X500

With newly incorporated features and uncompromising image quality, the UNICAM XE family covers all aspects of advanced broadcasting production from standard 4K/HD footage to high frame rates and XR applications effectively and efficiently.

Choose your UNICAM XE and experience a more versatile and streamlined production workflow.



LINEUP

UHK-X700

4K/HD Portable Camera System

4K HFR MoIP	4K 2160p	HD 1080p/i	HD 720p	F10/5994p F11/50p
	HDR	ADV HFR	EXT HFR	

UHK-X750

4K/HD Studio Camera System

UHK-X600

4K upgradeable
HD Portable Camera System

4K HFR MoIP	HD 1080p/i	HD 720p	F10/5994p F11/50p	HDR
	4K 2160p	ADV HFR		

UHK-X650

4K upgradeable
HD Studio Camera System

HDK-X500

HD Portable Camera System

HD MoIP	HD 1080p/i	HD 720p	F11/5994p F12/50p	HDR
	4K Upscaling			

Option

UHK-X750

Features

UNICAM XE

Natural Image Expression

The 3-CMOS optical system uses a 2/3-inch CMOS sensor and boasts an S/N of 62dB plus a sensitivity of F11 (2160/50p)/F10 (2160/59.94p) in 4K (UHK-X700). The high dynamic range of the sensor produces high-quality images with excellent color reproduction. The CMOS sensor incorporates a global shutter pixel architecture, enabling the camera to capture natural images even in challenging situations. Still frame replay of fast-moving objects is free from geometric distortion. And there are no flash bands when the camera is shooting under strobe lights or flashes from still cameras.

Rolling Shutter CMOS

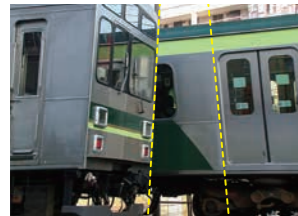

Geometric Distortion

Global Shutter CMOS



No Rolling Shutter Artifacts with Global Shutter



Flash-Band



High Frame Rate Capturing (Option)

The UHK-X700/X600 supports high frame capturing options (with BSX-100). With the EXT-HFR option, up to 2x speed in 4K and up to 8x speed in HD are supported.



	UHK-X700/X750	UHK-X600/X650
Advanced HFR x 2,3,4 in HD	Yes	Yes
Extended HFR x 2,3,4,6,8 in HD/x2 in 4K	Yes	No

HDR and Wide Color Gamut

HDR is supported by the HLG (Hybrid Log Gamma) system as standard. Wide color gamut shooting conforms to ITU-R BT.2020, enabling natural and rich color expression. The camera is equipped with customizable preset gamma curves and preset matrices for BT.2020 and BT.709 color reproduction, enabling optimal adjustment of the camera image to match the requirement of the current production.



Standard Dynamic Range



High Dynamic Range

Self-contained operation

The integrated video processor also enables self-contained operation in 4K. UNICAM XE can utilize a wide range of video devices as accessories to enhance its operational capabilities.

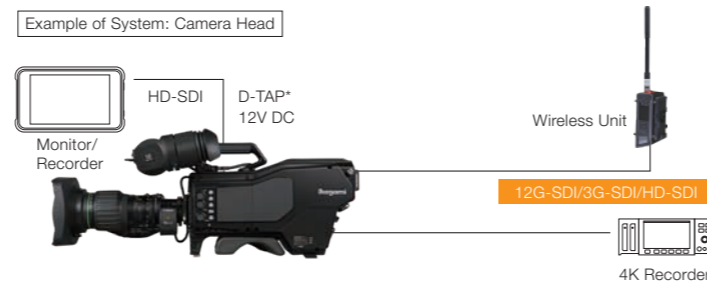

* D-TAP is available only for UHK-X700 & X600.

Images are for illustration

Exclusive Features of the UHK-X700 and X600

3840 x 2160 4K Capturing

The UHK-X700/X750 supports 3840 x 2160 effective resolution as standard. Applying an optional license key unlocks the UHK-X600/X650 for capturing the same 3840 x 2160 effective resolution images.

4K/HD Simulcast (Option for UHK-X600/X650)

The live image captured in 4K HDR can be delivered simultaneously in HD SDR from the base station. The image processing in the BSX-100 gives the optimum look for the converted images.

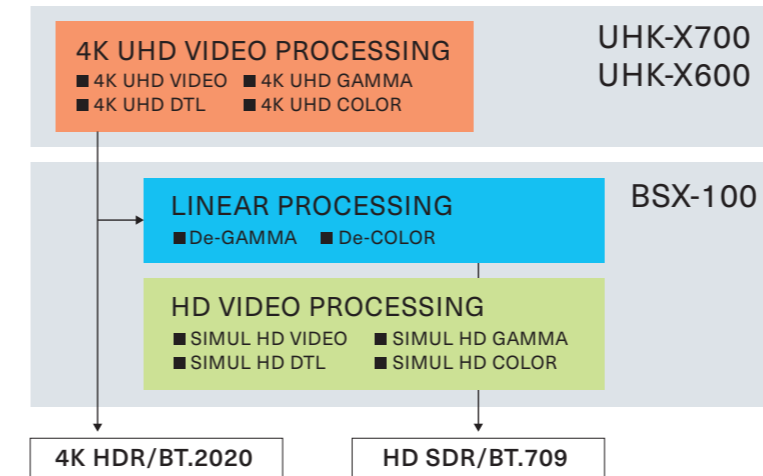

4K 12G-SDI Video Trunk (Option)

Utilizing a wide transmission bandwidth, the bi-directional 12G-SDI trunk line is available between the UHK-X700 and the BSX-100. Besides a main 4K image, the 4K Video Trunk (UHK-X700 to BSX-100, asynchronous signal) and the 4K QTV (BSX-100 to UHK-X700) can be transmitted at the same time on a Hybrid Fiber Optic cable.

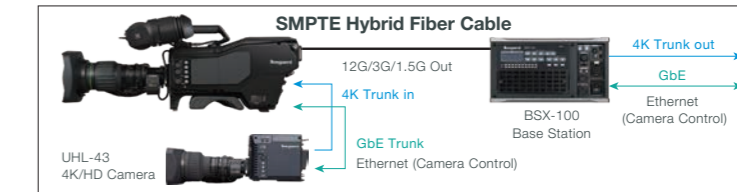

GbE Ethernet Trunk

An Ethernet data trunk line between the camera head and the BS supports the vast capacity of 1G bps. Data rate is constant and not affected by the video format to operate. Jumbo frame is to be supported.

Optimal Camerawork with Box Lenses

The UHK-X750/X650 allows optimal camerawork for live production with a large lens. Thanks to its low-profile body, the viewfinder can be positioned close to the height of the optical axis.



VF Position(SE)
VF Position(UHK-X750)
Optical Axis

Common features

16-axis Color Corrector

This function independently adjusts the hue and saturation of specific colors. It permits subjective manipulation of one color without affecting the other colors in the scene.

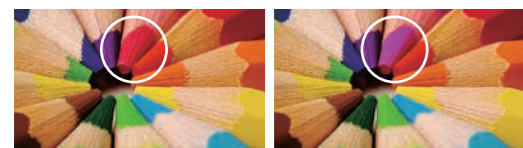

Original

Corrected

Remote Back Focus Adjustment (RBF)*

The OCP-300 & 500 can remotely adjust the back focus of a zoom lens. The adjustment is accurate and easy with a large display for the video engineer, even when the camera head is located in an environment where it is hard to clearly see the VF or reach the back focus on the lens.

* with supported lenses

Focus Assist

Contour extracted from the 4K image is displayed in the viewfinder to assist precise focusing. The size and color of the focusing area, and the color of the indicator, can be optimized by menu settings.



Optical Vignetting Correction (OVC)*

Automatic electronic compensation of F-drop and vignetting.

* with supported lenses

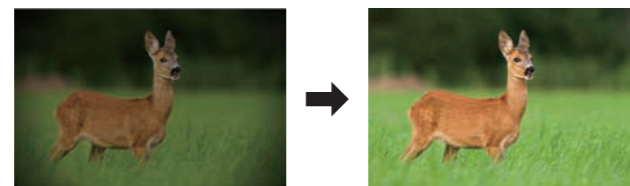

Lens Chromatic Aberration Correction (CAC)

With compatible lenses, the color fringing in peripheral images can be minimized.

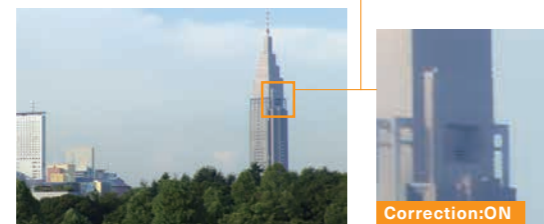

Ergonomic Design

As the UHK-X700 is a portable camera, the weight distribution ratio has been totally refined from its predecessor model.

A lower center of gravity and a well-balanced body help to reduce operator fatigue.



Wide adjustable range of shoulder pad



Shoulder pad is placed 30mm forward of the previous model



Improved field-of-view over the camera

Images for illustration

BSX-100

4K/HD Base Station

The BSX-100 is a base station that enhances the functions, performance, and operational capabilities of the UNICAM XE. It is compact and light weight, with 3U height and half-rack width. Supporting both 4K and HD formats, it is ideal for simulcast production and smooth transition from HD to 4K environments.



Front



Rear

Compatible with 4K & HD Cameras (Option)

The BSX-100 supports either HD cameras, 4K cameras, or both camera types. The following models are available:
BSX-100 U: for UNICAM XE (UHK-X700/X750/X600/X650) cameras
BSX-100 M: for UNICAM XE and Unicam HD (HDK-73/99) cameras
BSX-100 H: for UNICAM XE (HDK-X500) and Unicam HD cameras

4K & HD Simulcast*

The BSX-100 U and M have a total of 11 outputs as standard, including 4K output via 12G-SDI and 3G-SDI/HD-SDI.

* with supported cameras

Maximum Transmission Distance*

The BSX-100 extends the UNICAM XE camera up to 3.5 km (11,483 ft.) with a Hybrid Fiber Optic cable. In the Single Fiber mode, the cable length reaches up to 10 km (32,808 ft.).

* Depends on operating conditions.

Compact and Light Weight

3U height and half-rack width.



CCU-X100

Camera Control Unit

Employing the upscaled power supply unit, the CCU-X100 can extend the UNICAM XE cameras even over the greater distance.



Front Information Display

LED indicators can monitor the communication status between the camera head and the BS as well as the operational status. In the 7-segment LED display, the status of the device can be checked without entering the OSD menu, including system format, IP address (divided into octets), software version, and error information.



MoIP Interface

All UNICAM XE series products are designed to support the interoperability with the ST2110 media-over-IP network by incorporating an optional MoIP Module at the BSX-100/CCU-X100. Perfect for live sports, news broadcasts, and remote production environments, the BSX-100 MoIP bridges the baseband and the IP-based media workflows.

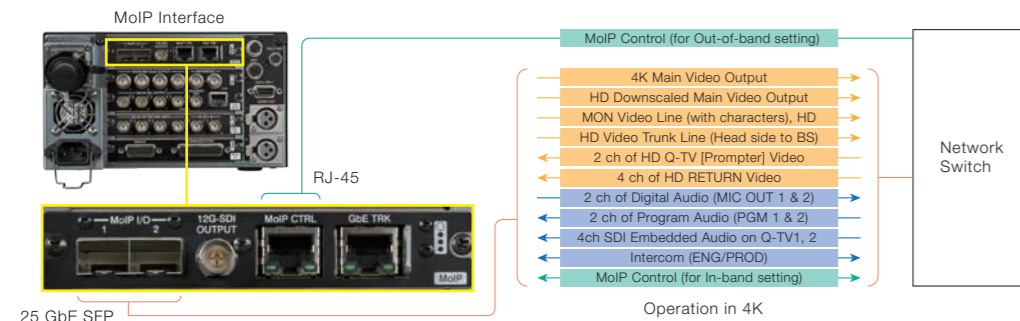

Support of NMOS

The AMWA NMOS (IS-04 & IS-05), which is widely adopted as a control method for IP networks, is supported, enabling device registration and interconnection within an IP network from broadcast controllers.

HFR, HDR, and UHD over IP streams

Not only the conventional 4K/HD program video output, HFR and HDR images can be output as IP streams with simultaneous output of the standard frame rate video for HFR capturing and HD SDR video for 4K HDR capturing.

Network Tally

The BSX-100 supports TSL V5.0 IP network tally protocol as standard.

IPX-100 IP Extension Unit



The IPX-100 is an external IP gateway for the UNICAM XE and Unicam HD cameras. By converting baseband signals to and from IP streams, the IPX-100 integrates the Unicam cameras directly to an ST2110 media-over-IP network.

Maximum Cable Extension

Using the trusted SMPTE hybrid fiber optic cable, the IPX-100 provides a stable connection and supplies remote power to the connected camera head up to 3500m.

Form factor

The compact 2U half-rack enclosure enables high-density mounting in an EIA rack. It is also easy to transport, making it ideal for field use. It is highly effective for a wide range of live video production applications.

JPEG XS (option)

The IPX-100 optionally supports JPEG XS (SMPTE ST2110-22 compliant) encoding and decoding. The IPX-100 provides the selectable data rate in four steps: High (1/5), Mid (1/8), Low (1/16), and Mini (1/32), allowing users to choose an optimal setting according to operational conditions.

IP Gateway function (option)

An optional IP Gateway function utilizes one of the conversion channels for external input and/or output, allowing SDI devices to seamlessly connect to the ST 2110 media-over-IP network without needing an external IP conversion box.

Ideal for IP Remote Production

The IPX-100 directly attaches UNICAM XE cameras to a media-over-IP network while maintaining the most trusted and widely used workflow with SMPTE fiber cables. With the aid of optional JPEG XS, the IPX-100 provides the most efficient workflow for IP remote production. Experience a more reliable and streamlined IP remote production workflow with the IPX-100.

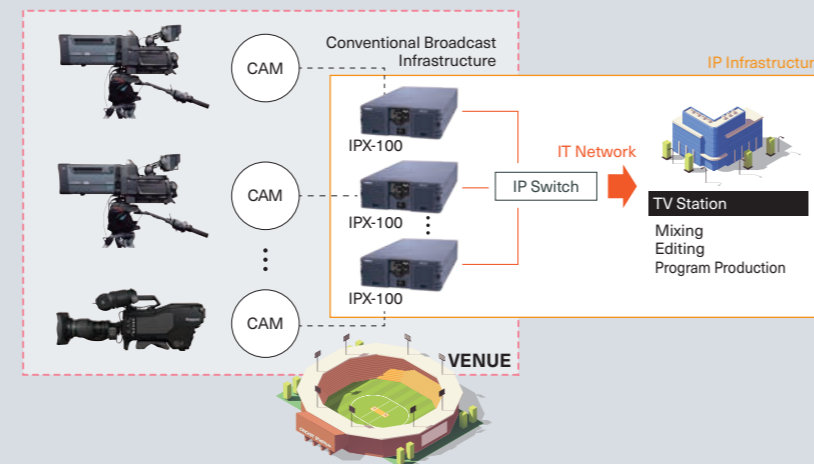

Accessories



2-inch LCD Ocular Viewfinder
VFL201D



7-inch Full-HD LCD Viewfinder
VFL-P700AD



System Expander
SE-U430



Tripod Adaptor
T-430



Shotgun Microphone
SGM-3500
A product of Azden Corp.

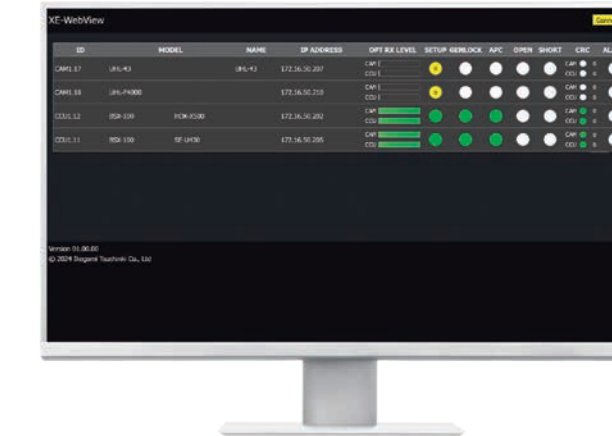

User interface on Web browser
XE WebView

XE WebView is a newly introduced web tool. With the aid of Ikegami Protocol Gateway, the web UI provides diagnostic information on the camera chains individually or in the overview. XE WebView enhances the flexibility and scalability of the camera systems, especially in the MoIP environment where device management is crucial.



New Operation Control Panel
OCP-500

With a slim panel surface measuring just 82mm (3.23 inches) wide, the newly developed OCP-500 offers space-saving efficiency without compromising functionality. Up to five OCP-500 units fit into the same desktop footprint as four OCP-300.

Features

- 2.8 inch LCD touch screen
- Self illuminated buttons
- Low power consumption
- USB for external storage



Master Control Panel
MCP-300



Operation Control Panel
OCP-300



Virtual Control Panel
VCP



Virtual Master-control Panel
VMP

Specifications

Camera Head		UHK-X700 UHK-X750	UHK-X600 UHK-X650	HDK-X500
Image Sensor		2/3-inch CMOS Sensor with Global Shutter Architecture		2/3-inch CMOS Sensor with Global Shutter Architecture
Optical System		2/3-inch 3-sensor, RGB Prism		
Effective Resolution	3840 x 2160 59.94p, 50p	Yes	Optional	No
	3840 x 2160 23.98p, 29.97p, 25p	Optional	Optional	No
	1920 x 1080 59.94p, 50p, 59.94i, 50i	Yes	Yes	Yes
	1920 x 1080 23.98p/SF, 29.97p/SF, 25p/SF	Optional	Optional	Optional
	1280 x 720 59.94p, 50p	Yes	Yes	Yes
1080p --> 2160p upscaling	No	No	with optional upscaler for BS	
Optical Filters (Servo Controlled)	Position	1	2	3
	ND CC	CLR 3200 K	1/4 4300 K	1/8 6300 K
S/N Ratio	4K	62 dB or better		—
	HD	62 dB or better		62 dB or better
Limiting Resolution	4K	2000 TVL or more		—
	HD	1000 TVL or more		1000 TVL or more
Sensitivity (2000 lux, 89.9% Reflection)		F10/59.94p, F11/50p		F11/59.94p, F12/50p
Gain-up		-6, -3, 0, +3, +6, +9, +12 dB		-6, -3, 0, +3, +6, +9, +12, +18 dB
Gamma Curves		OFF, 0.35, 0.4, 0.45, HLG, Custom 1 - 5		
Electronic Shutter		1/100, 1/120, 1/250, 1/500, 1/1000, 1/2000, and Variable Shutter		

Video I/O (Rear Panel)		Designation			
Video Out	SDI OUT 1-3	3 x BNC, 12G/3G/HD-SDI		SDI OUT 1-2	2 x BNC, 3G/HD-SDI
Video In/Out	SDI I/O 4	1 x BNC, 12G/3G/HD-SDI		SDI I/O 3	1 x BNC, 3G/HD-SDI
Reference Video In/Out	GL IN/	1 x BNC	In/put: Tri-Sync or BB		
	SYNC OUT		Output: BB		
I/O (Top Handle)		Designation			
Video Out	SDI OUT	1 x BNC, 3G/HD-SDI		SDI OUT	1 x BNC, 3G/HD-SDI (optional)

Other I/O		Designation			
SMPTE Hybrid Fiber Camera Cable		LEMO 3K Type (SMPTE 304M)			
Microphone	MIC 1/2	XLR-3, input level: -60 to +4 dBu/Phantom Power: Off/+12 V/+48 V			
Intercom	Intercom 1/2	XLR Type			
Phones	EARPHONE	1 x 3.5 mm Stereo mini jack		1 x 3.5 mm 4-pol mini jack (CTIA)	
Audio Out	PGM	XLR-3 (optional)			
Tracker	TRACKER	20-pin			
USB 2.0	USB	1 x Type-A, for USB flash drive			
Ethernet	LAN	1 x RJ-45, connection for OCP-300/500 (via PoE+ switch) or GbE Data Trunk for SE-U430		—	
System Expander	—				
DC Power Output		D-TAP: max. 2.5 A 12 V/DC OUT: max. 1.0 A 12 V		DC OUT: max. 1.0A 12 V	

General Specifications			
Ext. Power Input Voltage	UHK-X700/X600	+11 to 17 V DC	
	UHK-X750/X650	100 to 240 V AC	
Ambient Temperature	Operation: -20 °C to +45 °C (-4 °F to +113 °F)/Storage: -30 °C to +60 °C (-22 °F to +140 °F)		
Operation Humidity	30 % to 90 % *non-condensation		
Dimensions (Excluding protrusion)	UHK-X700/X600	W 148.5 x H 243 x D 340 mm/W 5.9 x H 9.6 x D 13.4 inches	
	UHK-X750/X650	W 315 x H 375.5 x D 398 mm/W 12.4 x H 12.9 x D 15.7 inches	
Weight (Camera Head)	UHK-X700/X600	Approx. 5 kg/11 lb	
	UHK-X750/X650	Approx. 18 kg/39.7 lb	
Power Consumption	UHK-X700/X600	85 W	
Max. in self-contained operation	UHK-X750/X650	120 W	

BSX-100/CCU-X100 Type U and M	
Supported Camera Models	
UHK-X700/X750, UHK-X600/X650	Type U and M
HDK-X500	Type M
HDK-99, HDK-73	Type U

Video I/O		Designation			
Video In	RET	4 x BNC	4-input or 2-in/2-out (Active Loop-through)		
	HD QTV	2 x BNC	2-input or 1-in/1-out (Active Loop-through)		
	4K QTV	1 x BNC	12G-SDI, shared with 12G OUT 3-4 * (option)		
	OUT 1-4	4 x BNC	4K 3G-Quad Link (2S) or 3G/HD		
	OUT 5-8	4 x BNC	3G/HD, OUT 8 is for HD-SDI MON out		
Video Out	12G OUT 1-4	4 x BNC	4K 12G-SDI or 3G-Quad Link (2S)		
	HD TRUNK	1 x BNC	HD-SDI, shared with OUT 5-7 *		
	4K TRUNK	1 x BNC	12G-SDI, shared with 12G OUT 3-4 * (option)		
	REFERENCE	2 x BNC	Tri-Sync or BB, Active Loop-through		
	SYNC/AES	1 x BNC	Tri-Sync out or Digital Audio out (AES/EBU)		

Optional MoIP I/O		Designation	
IP Media Stream	MoIP I/O	2 x SFP	10G/25G
Video Out	12G-SDI OUTPUT	1 x BNC	4K 12G-SDI or 3G/HD-SDI
NMOS Control	MoIP CTRL	1 x RJ-45	JT-NM TR1001

Other I/O		Designation			
SMPTE Hybrid Fiber Camera Cable		LEMO 3K Type (SMPTE 304M)			
System I/F	COMMUNICATION	D-Sub 25-pin	Intercom, PGM Audio & Tally In		
Mic Gain Remote	REMOTE	D-Sub 15-pin	Enable/Fine Gain/Step Gain		
Data Trunk CH-1	DATA TRK-1	D-Sub 9-pin	RS-422		
Data Trunk CH-2	IF	12-pin	RS-422, Preview, etc.		
Data Trunk (Ethernet)	GbE TRK	1 x RJ-45	Max. 1000BASE-T (for UHK-X700/X600)		
Tally Out	TALLY OUT	5-pin			
Audio Out	AUDIO OUT-1/2	XLR-3	Analog Microphone Output		
Command Control	OCP	8-pin	CP Connector		
	LAN	RJ-45	ICCP over Ethernet, TSL Tally (V5.0)		

BSX-100/CCU-X100 General Specifications		
Input Voltage	BSX-100 & CCU-X100	100 to 240 V AC ±10%
Power Consumption	BSX-100	max. 100 VA (Type U)
	CCU-X100	max. 120 VA (Type M)
Ambient Temperature	BSX-100 & CCU-X100	Operation: 0 °C to +40 °C (32 °F to +104 °F) Storage: -30 °C to +60 °C (-22 °F to +140 °F)
Operation Humidity	BSX-100 & CCU-X100	30 % to 90 % *non-condensation
Dimensions (Excluding protrusion)	BSX-100	W 216 x H 123.6 x D 417.2 mm/W 8.5 x H 4.9 x D 16.0 inches
	CCU-X100	W 482.6 x H 132.6 x D 398 mm
Weight	BSX-100	Approx. 7 kg/15.5 lb
	CCU-X100	Approx. 17 kg/37.5 lb

BSX-100/CCU-X100 Type H	
Supported Camera Models	
HDK-X500	
HDK-99, HDK-73	

Video I/O		Designation			
Video In	RET	4 x BNC	4-input or 2-in/2-out (Active Loop-through)		
	HD QTV	2 x BNC	2-input or 1-in/1-out (Active Loop-through)		
Video Out	OUT 1-4	4 x BNC	3G/HD, 4K 3G-Quad Link (upscaling from 1080p) as option		
	OUT 5-8	4 x BNC	3G/HD, OUT 8 is for HD-SDI MON out		
	12G OUT 1-4	4 x BNC	12G-SDI or 3G-Quad Link (option)		
	HD TRUNK	1 x BNC	HD-SDI, shared with OUT 5-7 *		
	REFERENCE	2 x BNC	Tri-Sync or BB, Active Loop-through		
Genlock	SYNC/AES	1 x BNC	Tri-Sync out or Digital Audio out (AES/EBU)		

Optional MoIP I/O		Designation	
IP Media Stream	MoIP I/O	2 x SFP	10G
Video Out	12G-SDI OUTPUT	1 x BNC	SMPTE ST2110 Compliant
NMOS Control	MoIP CTRL	1 x RJ-45	JT-NM TR1001

Other I/O		Designation			
SMPTE Hybrid Fiber Camera Cable		LEMO 3K Type (SMPTE 304M)			
System I/F	COMMUNICATION	D-Sub 25-pin	Intercom, PGM Audio & Tally In		
Mic Gain Remote	REMOTE	D-Sub 15-pin	Enable/Fine Gain/Step Gain		
Data Trunk CH-1	DATA TRK-1	D-Sub 9-pin	RS-422		
Data Trunk CH-2	IF	12-pin	RS-422, Preview, etc.		
Tally Out	TALLY OUT	5-pin			
Audio Out	AUDIO OUT-1/2	XLR-3	Analog Microphone Output		
Command Control	OCP	8-pin	CP Connector		
	LAN	RJ-4	ICCP over Ethernet, TSL Tally (V5.0)		

IPX-100	
Supported Camera Models	
UHK-X700/X750, UHK-X600/X650	Type U and M
HDK-X500	Type H and M
HDK-99, HDK-73	Type H and M

Optional MoIP I/O		Designation	
IP Media Stream	MoIP I/O	2 x SFP	10G/25G
NMOS Control	NMOS	1 x RJ-45	JT-NM TR1001
Command Control	CAM CTRL	1 x RJ-45	ICCP over Ethernet, TSL Tally (V5.0)
Data Trunk (Ethernet)	GbE TRK	1 x RJ-45	max. 1000BASE-T (for UHK-X700/X600)

Video I/O		Designation			
Video In	SDI to IP	1 x BNC	for optional IP Gateway function		
Video Out	MON	1 x BNC	HD-SDI MON out		
	IP to SDI	1 x BNC	for optional IP Gateway function		

Other I/O		Designation			
SMPTE Hybrid Fiber Camera Cable		LEMO 3K Type (SMPTE 304M)			

General Specifications	
Input Voltage	100 to 240V AC ±10%
Power Consumption	max. 130W (Type U)
Ambient Temperature	Operation: 0 °C to +40 °C (32 °F to +104 °F) Storage: -30 °C to +60 °C (-22 °F to +140 °F)
Operation Humidity	30 % to 90 % *non-condensation
Dimensions (Excluding protrusion)	W 216 x H 79 x D 407.2 mm
Weight	Approx. 5 kg/11 lb